

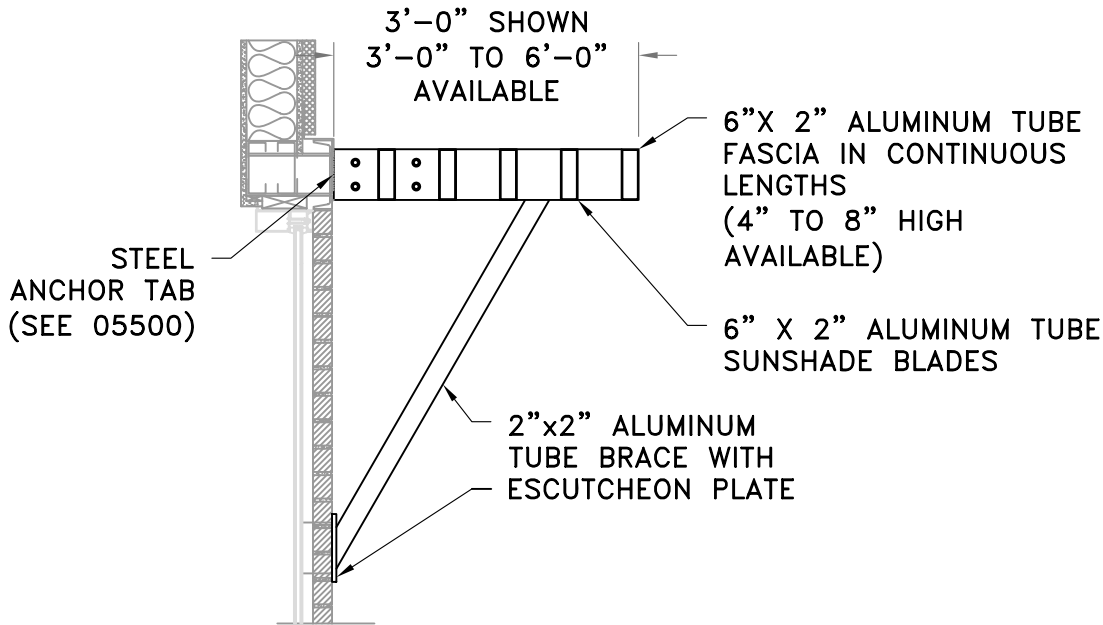

1 PLAN VIEW
1/4" = 1'-0"



A SECTION VIEW
3/4" = 1'-0"



		3 MARKET SQUARE PORTSMOUTH, NH 03801 USA TEL: (603) 433-6700 FAX: (603) 433-3349 INFO@ASCA-DESIGN.COM	
		WWW.ASCA-DESIGN.COM	
MODEL NO:	PROJECT / CLIENT:		
SH-2575	DATE:	PM:	